

NO.	REVISIONS	DATE	DEVISER
1.			
2.			
3.			

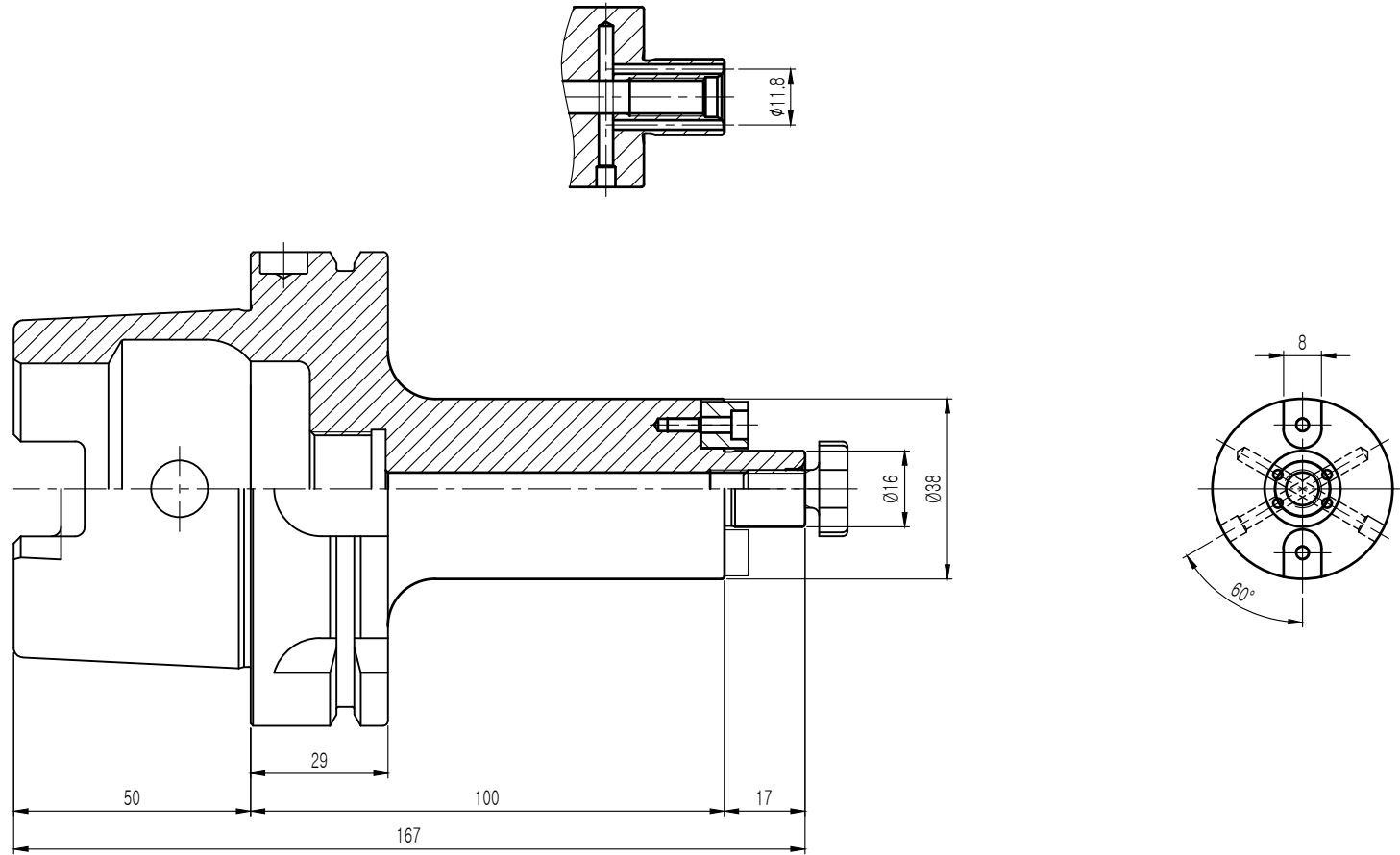

YG YG-1 CO., LTD.

DESCRIPTION

HSK100A-SMA16C-100

EDP No. ER006C SCALE 1 : 1