

NO.	REVISIONS	DATE	DEVISER
1.			
2.			
3.			

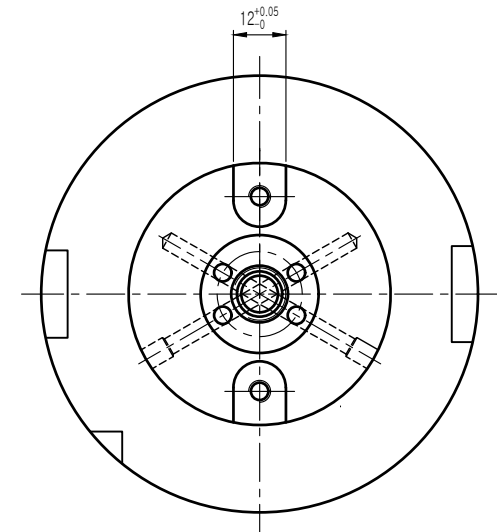
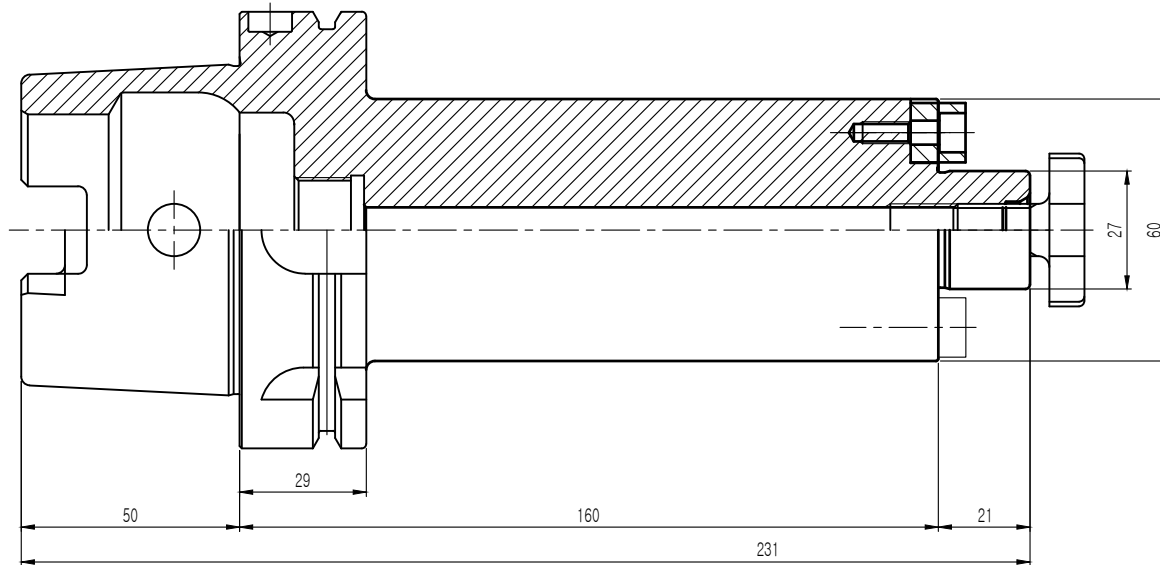
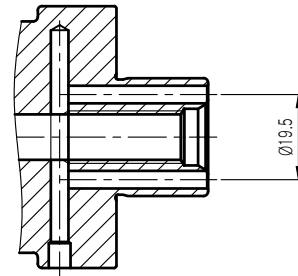

YG YG-1 CO., LTD.

DESCRIPTION

HSK100A-SMA27C-160

EDP No. ER010C SCALE 1 : 1