

NO	REVISIONS	DATE	DEVELOPER
1.			
2.			
3.			

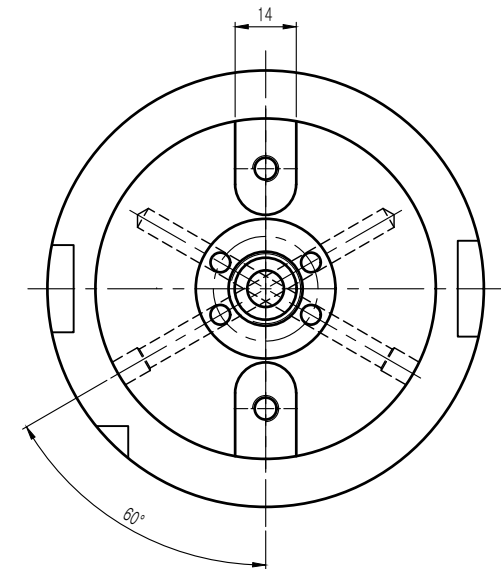
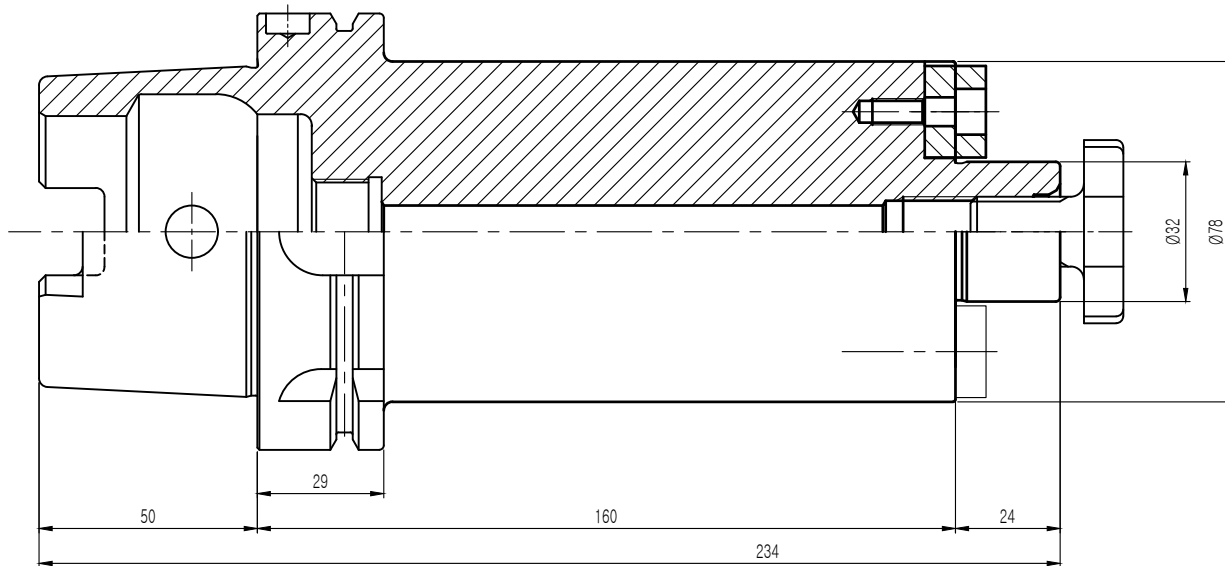
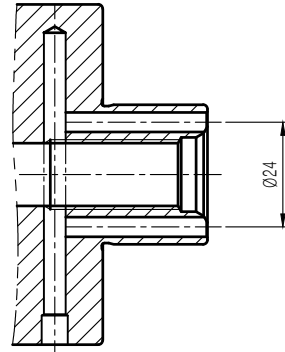

YG YG-1 CO., LTD.

DESCRIPTION

HSK100A-SMA32C-160

EDP No.

ER012C

SCALE 1 : 1