

NO.	REVISIONS	DATE	DEVISER
1.			
2.			
3.			

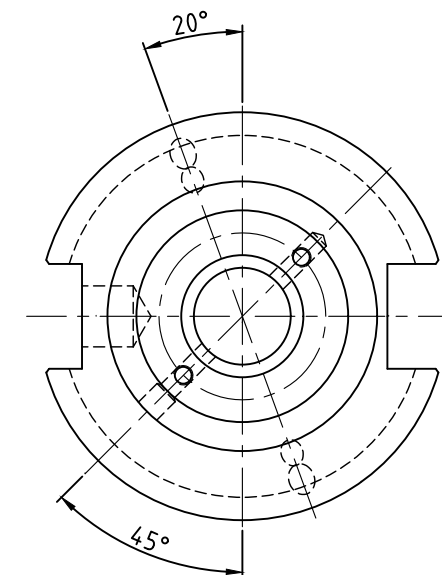
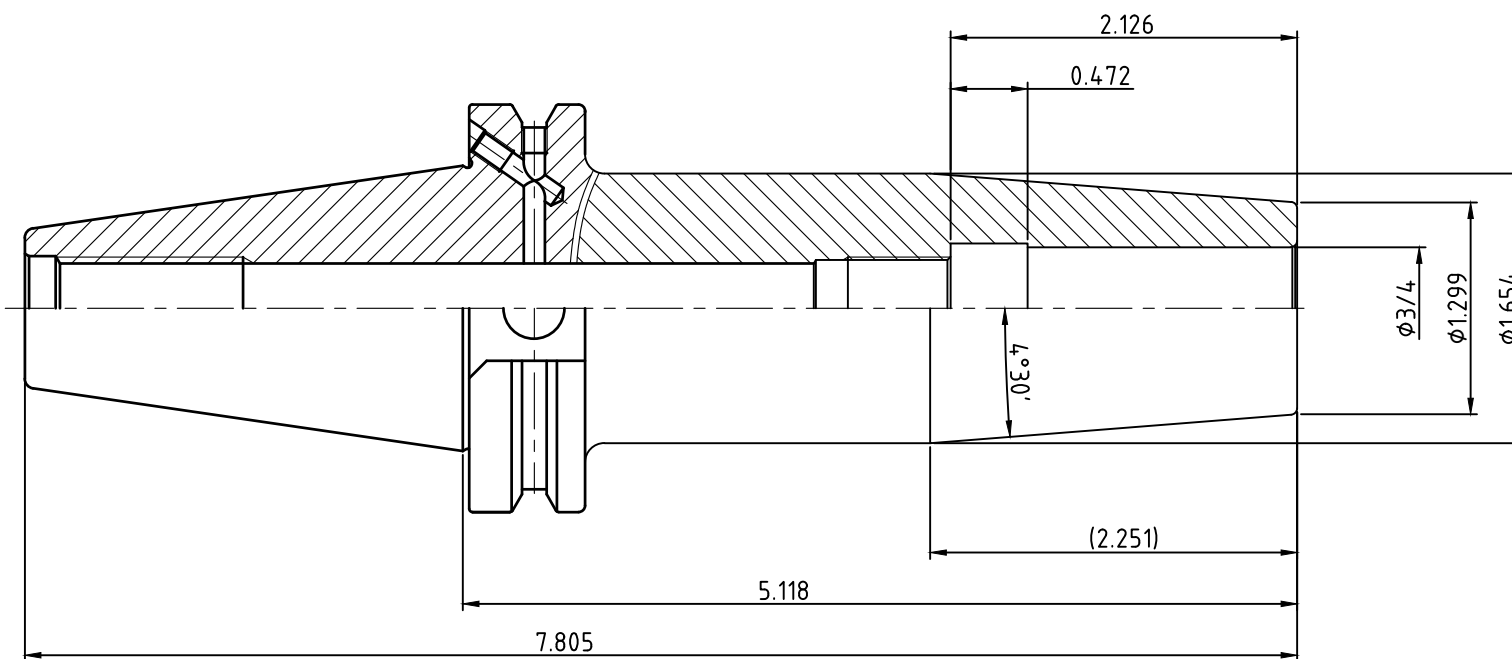
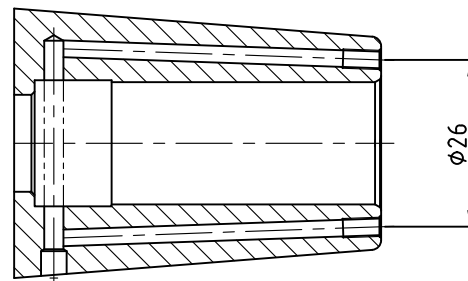

YG YG-1 CO., LTD.

SSK CONTROL NUMBER

CCT40AD/B-SFH19.05(3/4")CR-130(5.12")

EDP No. VB209JR SCALE 1 : 1