

NO.	REVISIONS	DATE	DEVISER
1.			
2.			
3.			

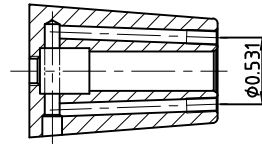

SECTION A-A'

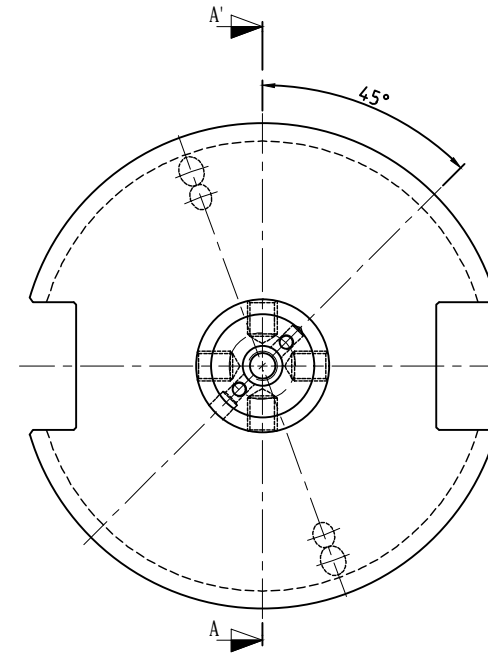
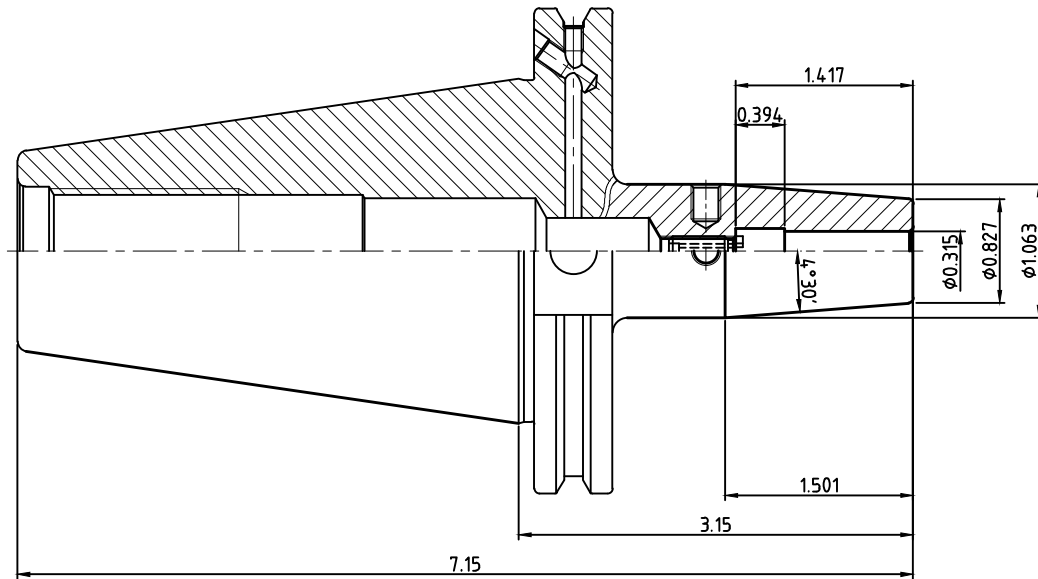

	DESCRIPTION		
	CAT50AD/B-SFH8CR-80		
	EDP No.	VL113JR	SCALE 1 : 1