

NO.	REVISIONS	DATE	DEVISER
1.			
2.			
3.			

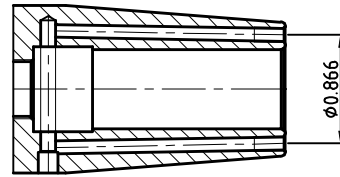

SECTION A-A'

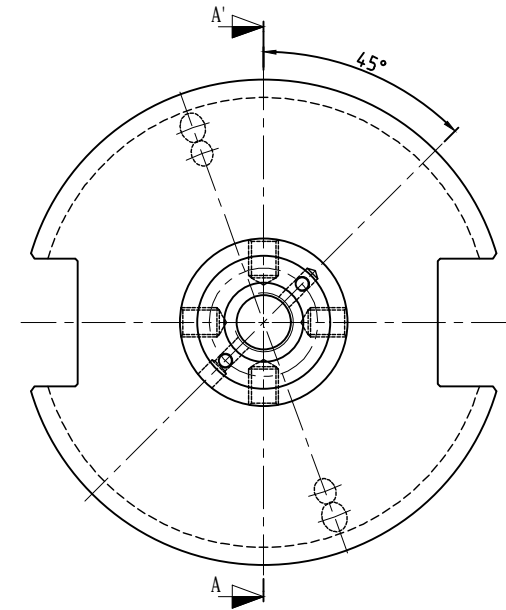
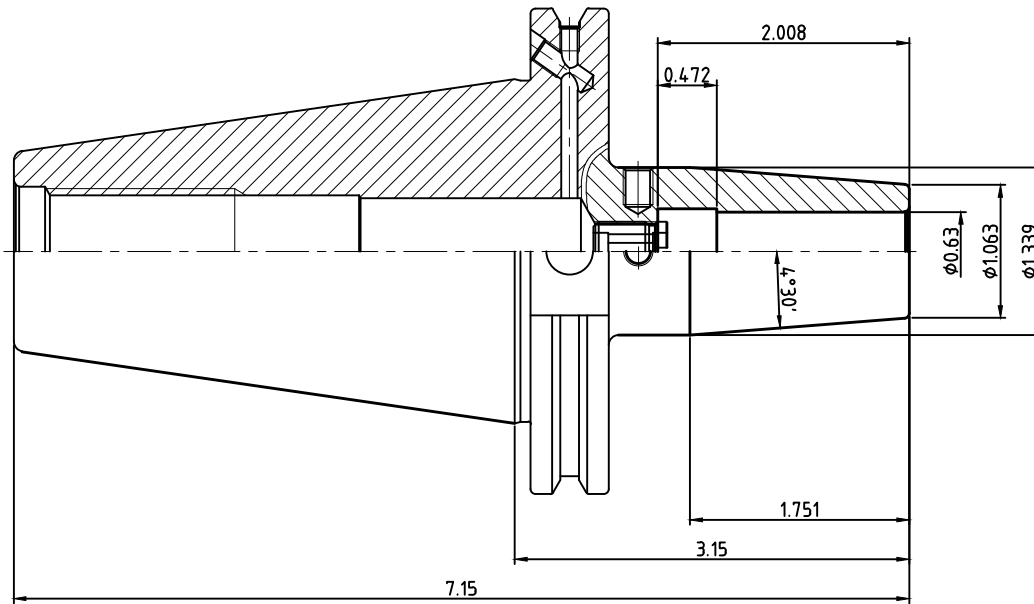

YG YG- 1 CO., LTD.

DESCRIPTION

CAT50AD/B-SFH16CR-80

EDP No. VL121JR SCALE 1 : 1