

NO.	REVISIONS	DATE	DEVISER
1.			
2.			
3.			

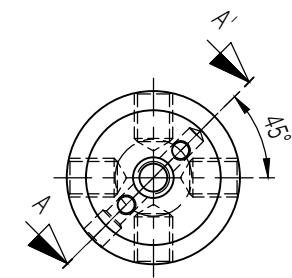
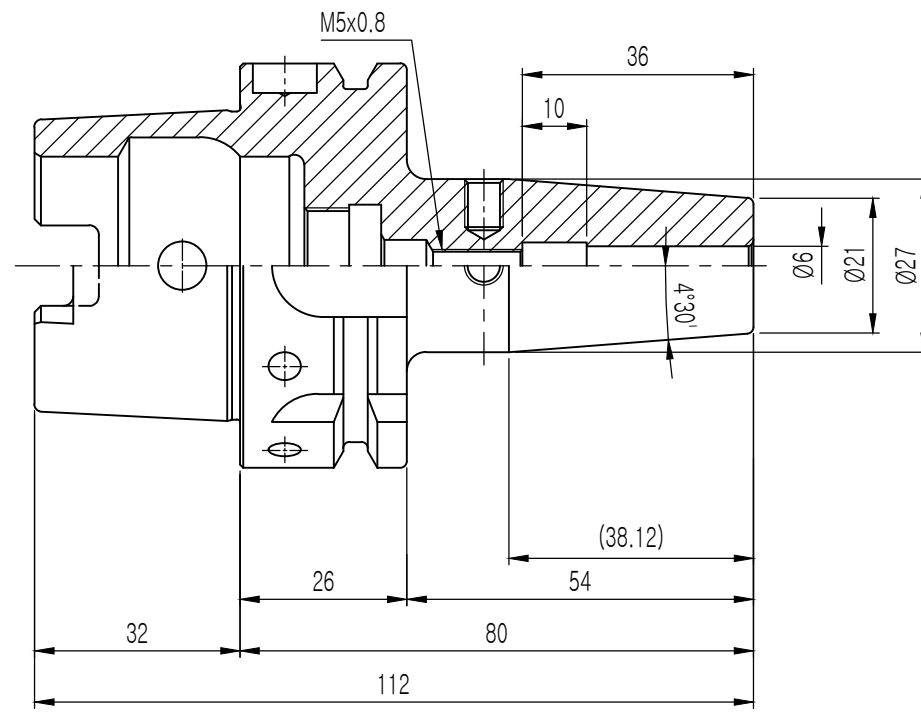
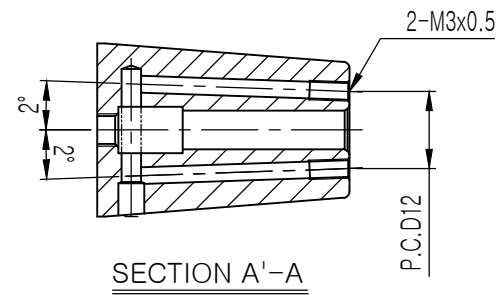

	DESCRIPTION		
	HSK63A-SFH6CR-80		
	EDP No.	VQ110JR	SCALE 1 : 1