

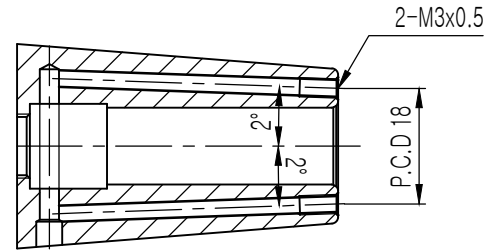

NO.	REVISIONS	DATE	DEVISER
1.			
2.			
3.			

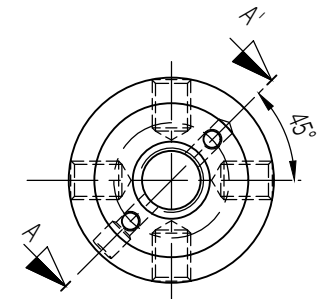

SECTION A'-A

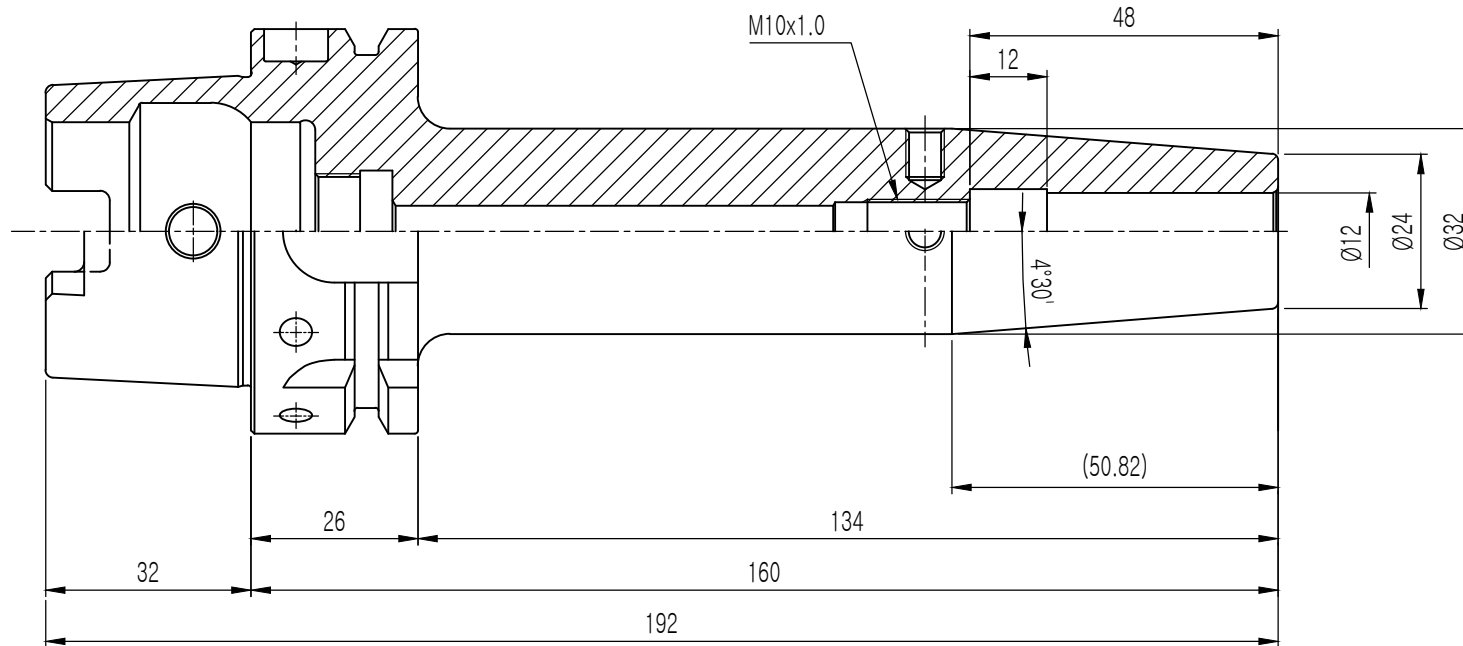

 YG-1 CO., LTD.	DESCRIPTION		
	HSK63A-SFH12CR-160		
	EDP No.	VQ117JR	SCALE 1 : 1